



Threat Identification, Recognition, and Response

Threats for the Shipping Industry



Threats for the Shipping Industry

Since Sept 11 2001, the world in which ships trade has changed, perhaps forever.

We must all contribute to the effort – contending with new rules governing, security, customs and immigration; recognising the legal and insurance responsibilities we have; and adjusting to the shifting economic and trade environment.

Recognition and detection of weapons, dangerous substances and devices

- Physical search
- X-Ray screening
- Low powered radar sensors
- Walk through detectors
- Trace detectors
- Screening containers
- Dirty bombs



Weapons

Recognition and detection of weapons, dangerous substances and devices

- Not as easy as it sounds, within the military and civilian field there numerous cases to attend from using different weapons to identifying foreign equipment and weapons of various sizes, designs, makes , models etc. And the experience gained cannot be passed on over night.
- It requires experts in the relevant fields to be able to recognise and detect weapons, dangerous substances and devices. What we are concerned with is the prevention of such materials entering the ports and on board vessels. To achieve this we require controls similar to airport security systems.
- X-Ray screening to detect weapons made of metal, plastic, ceramics etc.
- Low powered radar sensors to detect weapons
- Walk through detectors
- Trace detectors for dangerous substances and confirming cargos, illegal immigrants etc.
- Screening containers for chemical, biological, radioactive or nuclear cargo

Recognition and detection of weapons, dangerous substances and devices

- Dirty bombs - Radioactive material surrounded by explosive. Detonation spreads the radioactivity over a wide area, killing potentially hundreds of people and leaving whole areas uninhabitable for decades. As reported in the press Feb 1 2003 British Intelligence services have uncovered a plot by Al Qaeda to build a nuclear dirty bomb after discovering documents in Herat in Afghanistan indicating that the bomb had been assembled. The whereabouts are unknown and it is feared it could have been moved along the smuggling routes which spread west from Herat close to the Iranian border .
- To make ourselves less vulnerable by the use of education, awareness and the introduction of security procedures coupled with important intelligence will enable crews and personnel to identify suspicious materials and report them to the correct authorities for identification.

PISTOL 9MM

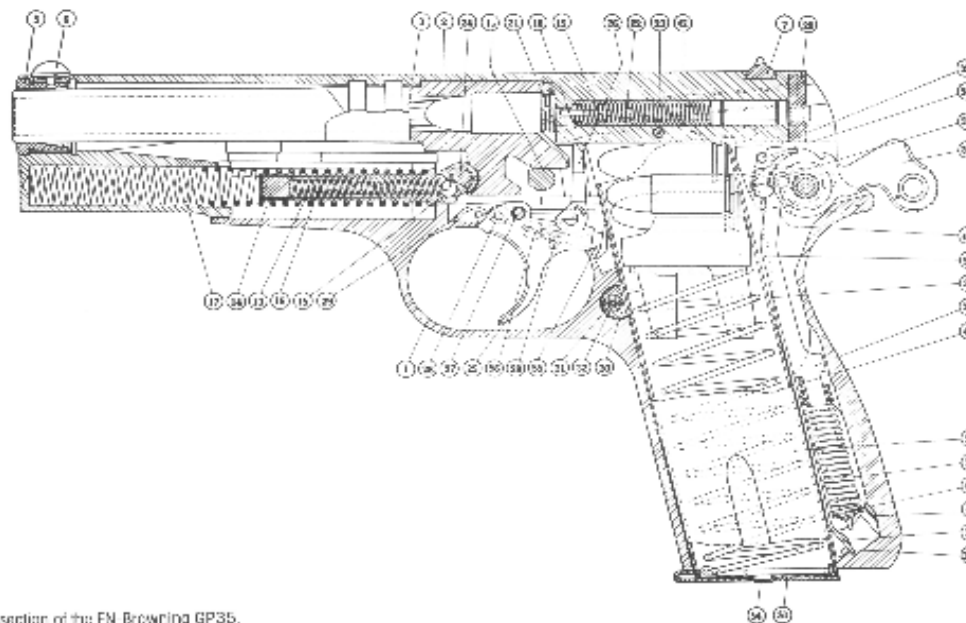
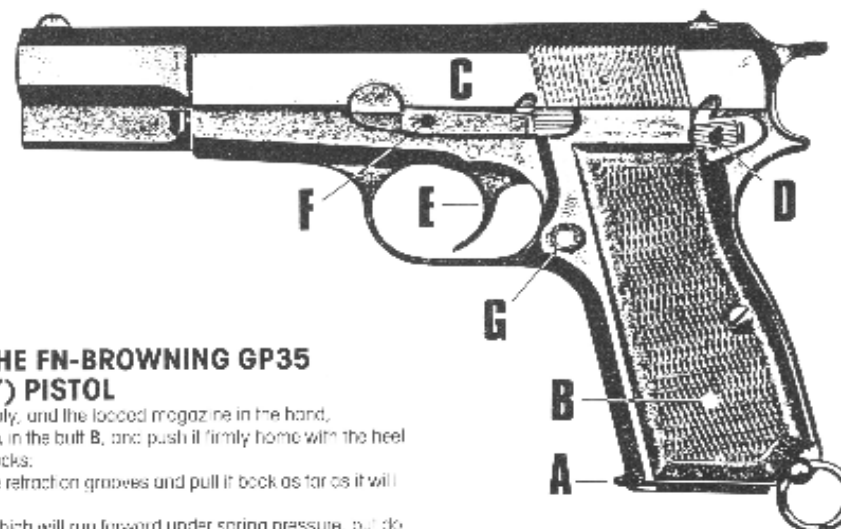

Fig. 6. A longitudinal section of the FN Browning GP35.
Courtesy of Fabrique Nationale.



HOW TO FIRE THE FN-BROWNING GP35 ('HIGH-POWER') PISTOL

- Starting with the gun empty, and the loaded magazine in the hand,
- > insert the magazine A in the butt B, and push it firmly home with the heel of the palm to ensure it locks;
 - > grip the slide C by the retraction grooves and pull it back as far as it will go;
 - > release the slide C, which will run forward under spring pressure, but do

Fig. 7. An exploded drawing of the FN-Browning GP3.
Courtesy of Fabrique Nationale.

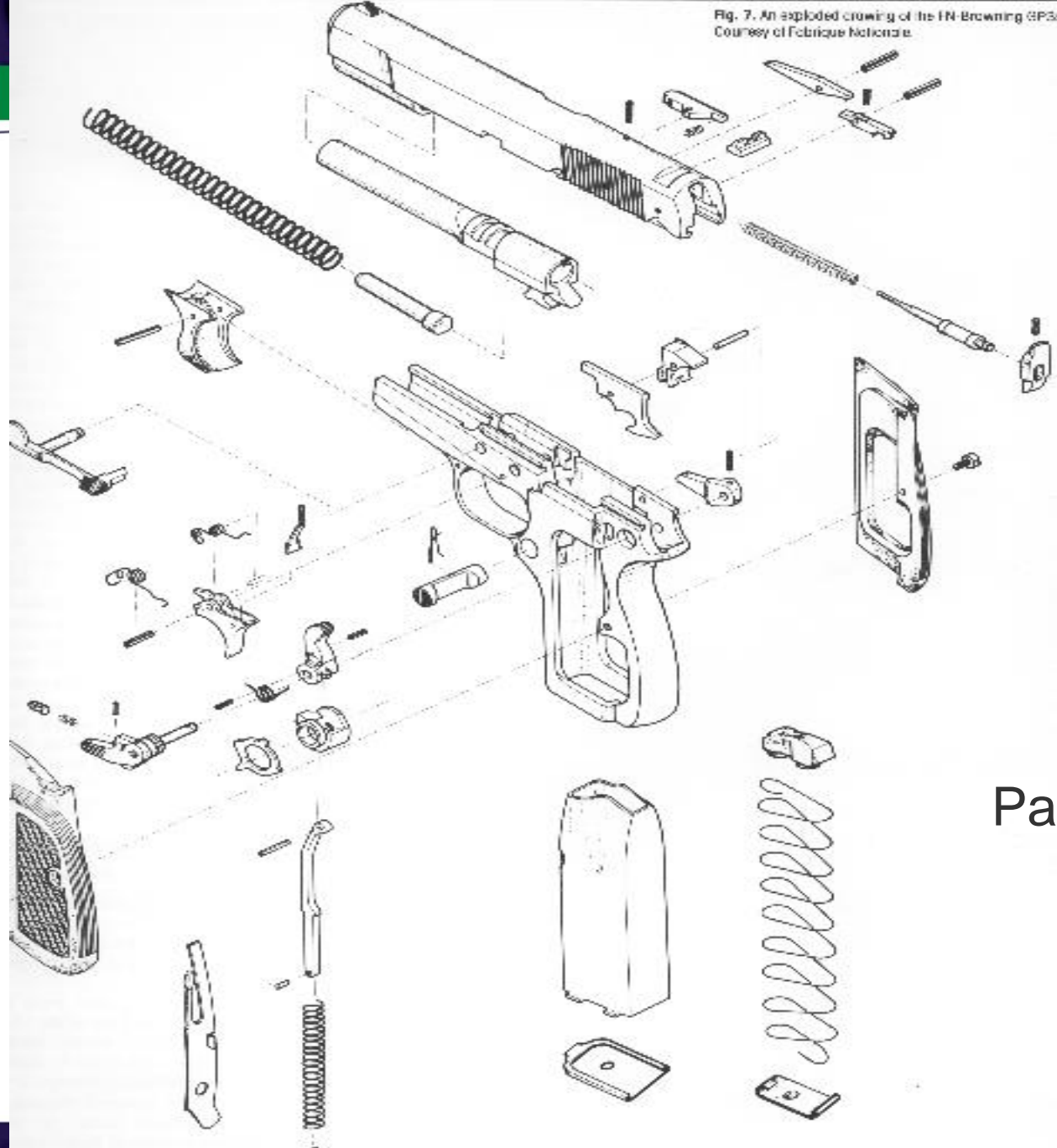

Parts

AK 47 / AKM - RUSSIA, CHINA, SOVIET BLOCK STATES



Assault Rifles

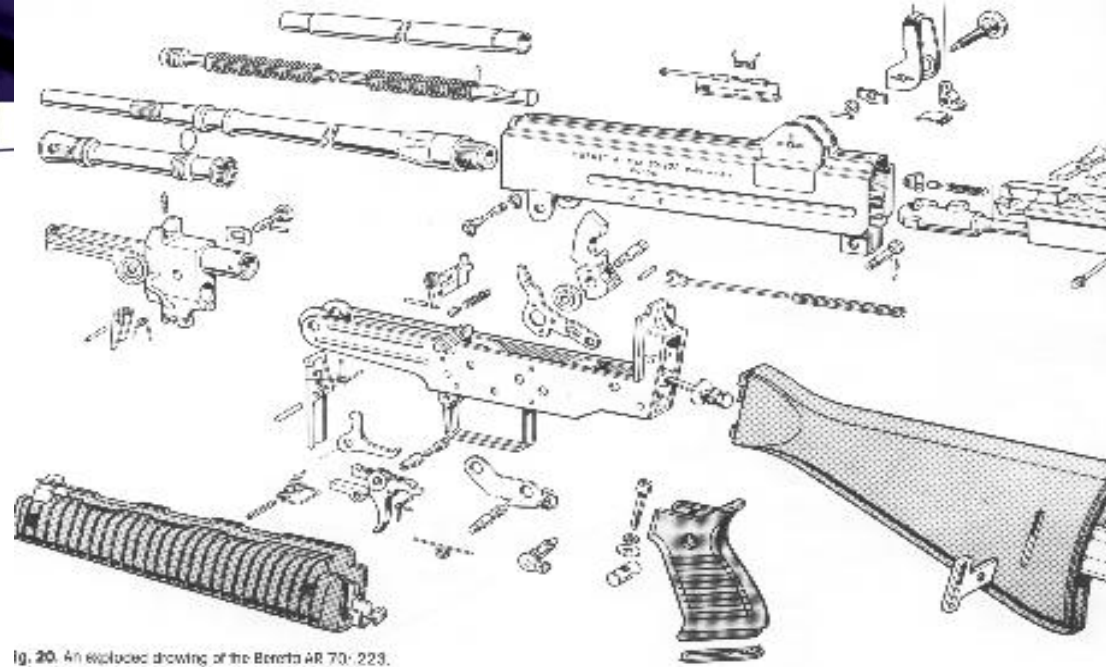

Fig. 20. An exploded drawing of the Beretta AR 70-223, one of which have found their way into the hands of the Iraqi HOCs and SIS. Courtesy of Pietro Beretta SpA.

Parts

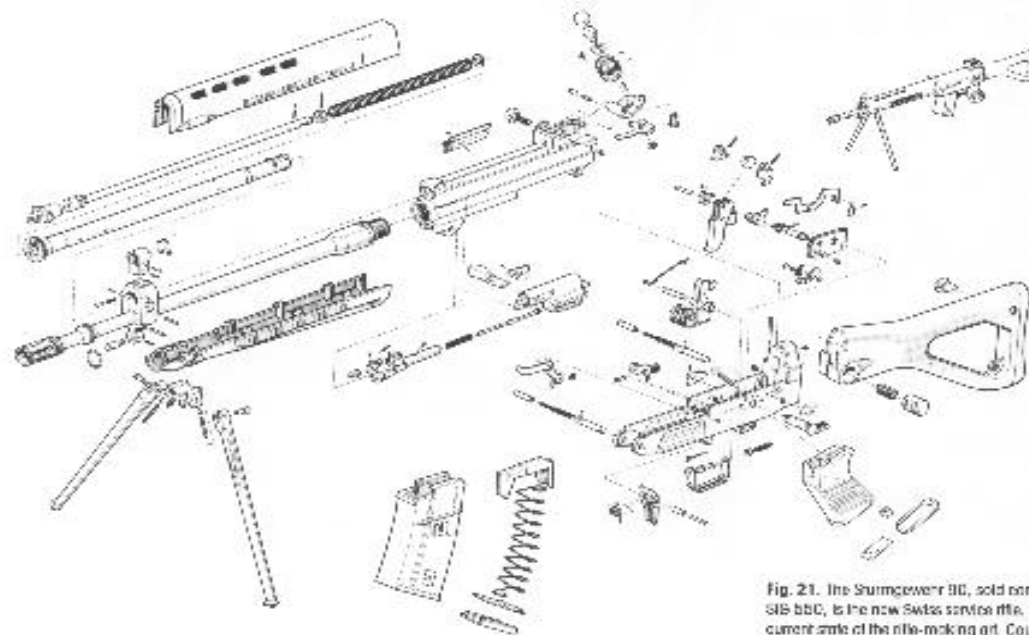

Fig. 21. The Sturmgewehr 90, sold as the SIS b90, is the new Swiss service rifle. It is the current state of the rifle-making art. Courtesy of...

Heckler Koch - GERMANY/- Heckler Koch (Germany / UK)UK



79

Machine Pistols



0

Cal: 9mm

Weight: 3.425kg (7.55lb)

Length: 368mm (14.49")

CRFire: 550rpm

Mag: 32rnds

Ingram - MAC 10 (USA)

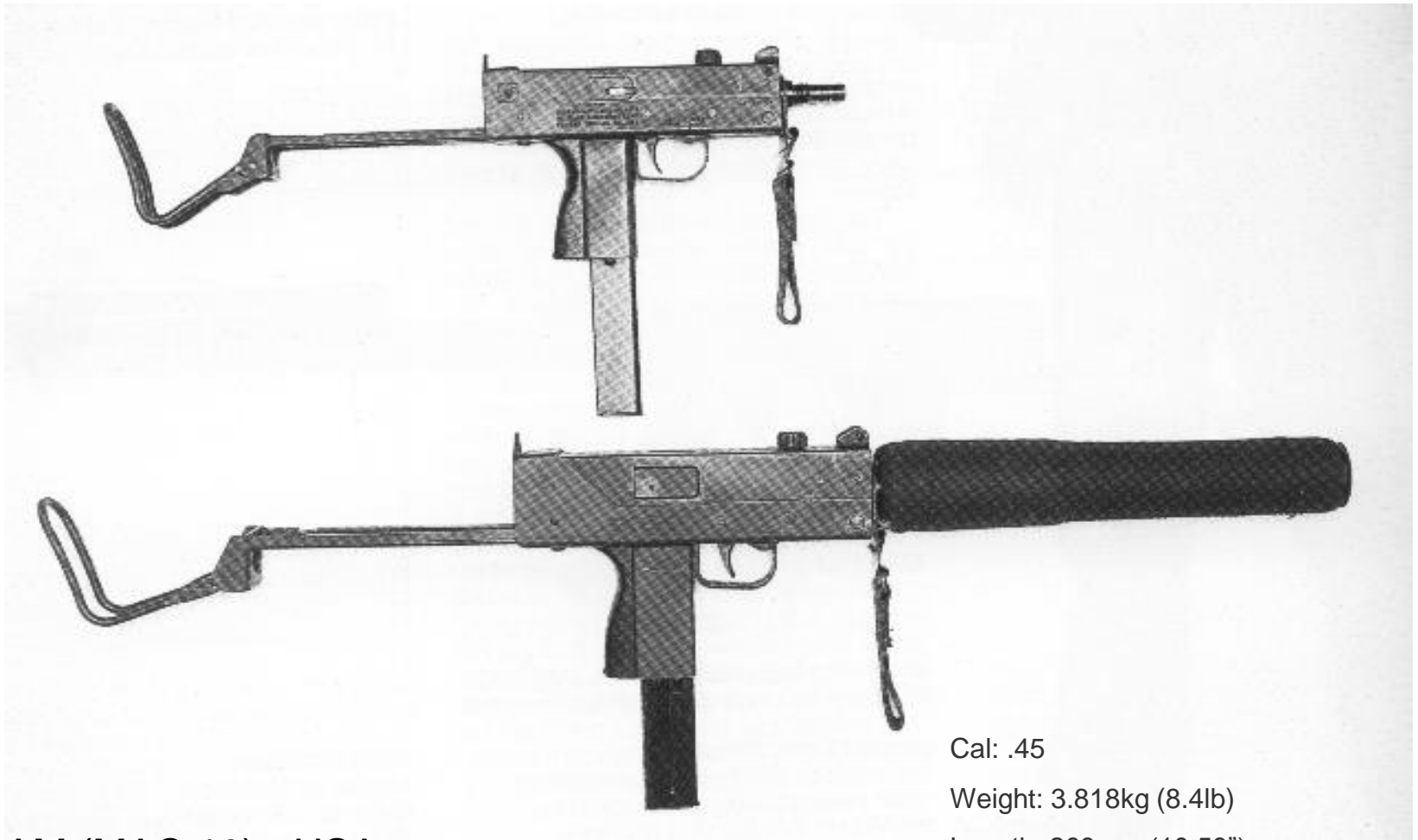

INGRAM (MAC 10) - USA

Cal: .45

Weight: 3.818kg (8.4lb)

Length: 269mm (10.59")

CRFire: 1.145rpm

Mag: 30rnd

Uzi - Israel



UZI - ISRAEL

Cal: 9mm

Weight: 3.11kg ((6.85lb)

Length: 360mm (14.17")

CRFire: 950rpm

Mag: 20,25,32rnds



SKORPION - CZECH



Favourite weapon of
the PLO

Skorpion favourite weapon
for the PLA

GRENADES



Dangerous Substances

BANNED SUBSTANCES: COCAINE



BANNED SUBSTANCES: SLEEPING MEDICIN



BANNED SUBSTANCES: ECSTASY



BANNED SUBSTANCES: MARIJUANA/HASH/WEED



Devices

DETONATORS

NON - ELECTRIC

1.75" / 4.4mm



L1A1 - DOES NOT NEED PRIMER (IE. EXTRA POWER TO DETONATE EXPLOSIVE).

ELECTRIC

2" / 5mm



L2A1 - DOES NOT NEED PRIMER TO DETONATE EXPLOSIVE

RESISTORS



RESISTORS FORM 2 FUNCTIONS.

1. LIMIT (RESIST) THE FLOW OF CURRENT THROUGH A CIRCUIT.
2. SET VOLTAGE LEVELS AT SPECIFIC POINTS IN A CIRCUIT

Variable Resistor

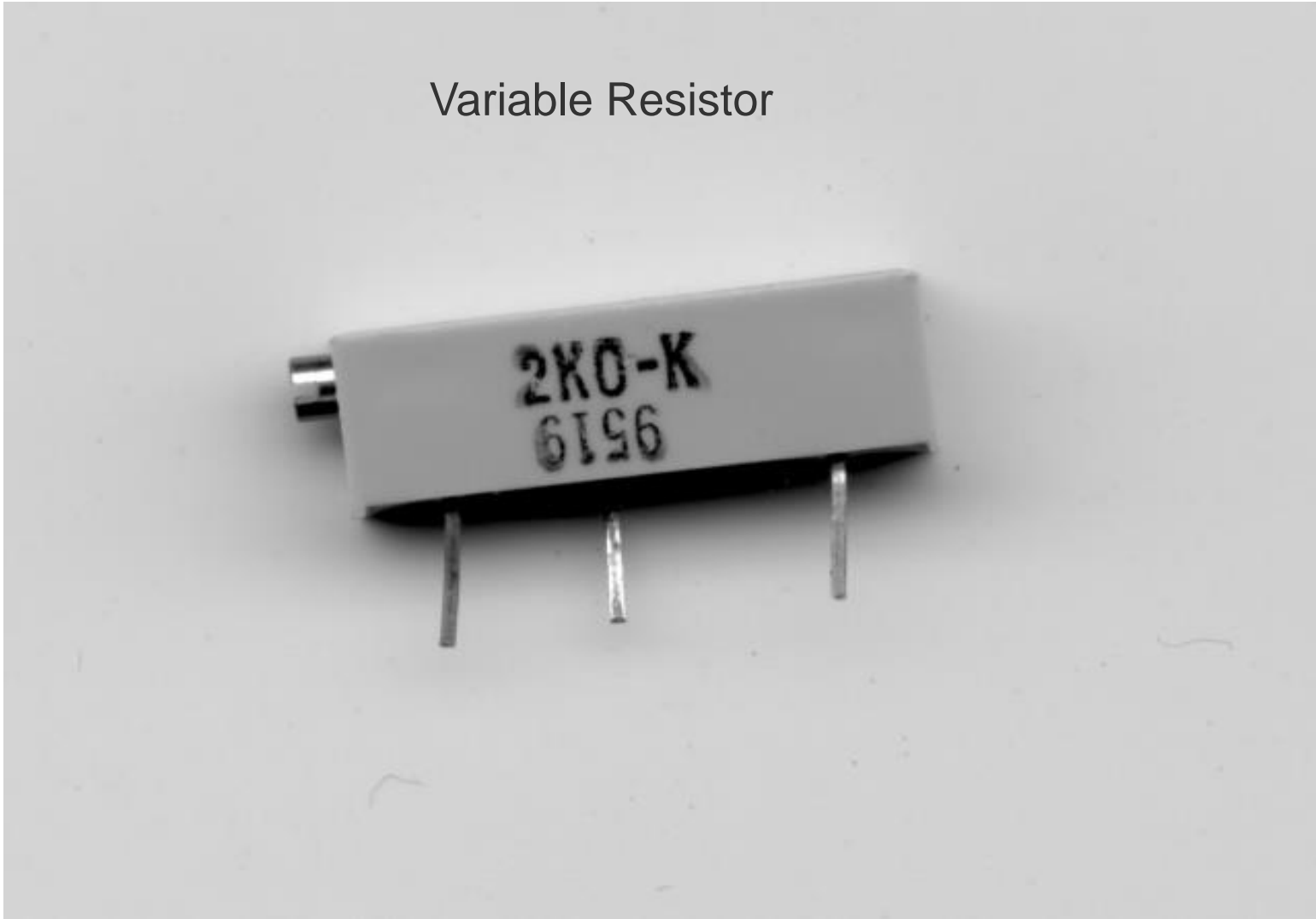

THYRISTOR / SCR

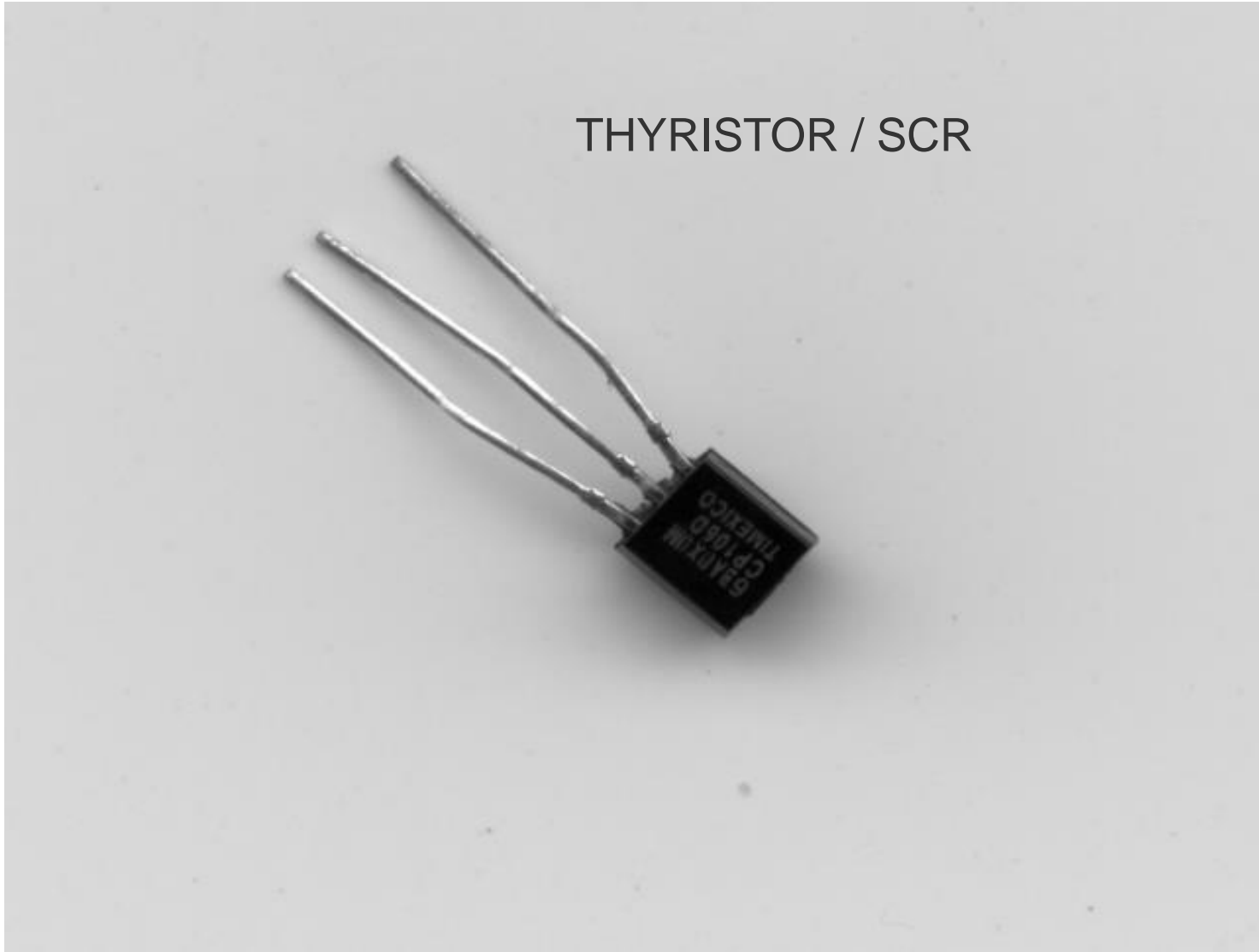

CAPACITOR



STORES A CHARGE UNTIL IT IS RELEASED. USED FOR

1. LONG CHARGING PERIOD (TIME DELAY)
2. RAPID DISCHARGE

ADDITIONAL EQUIPMENT

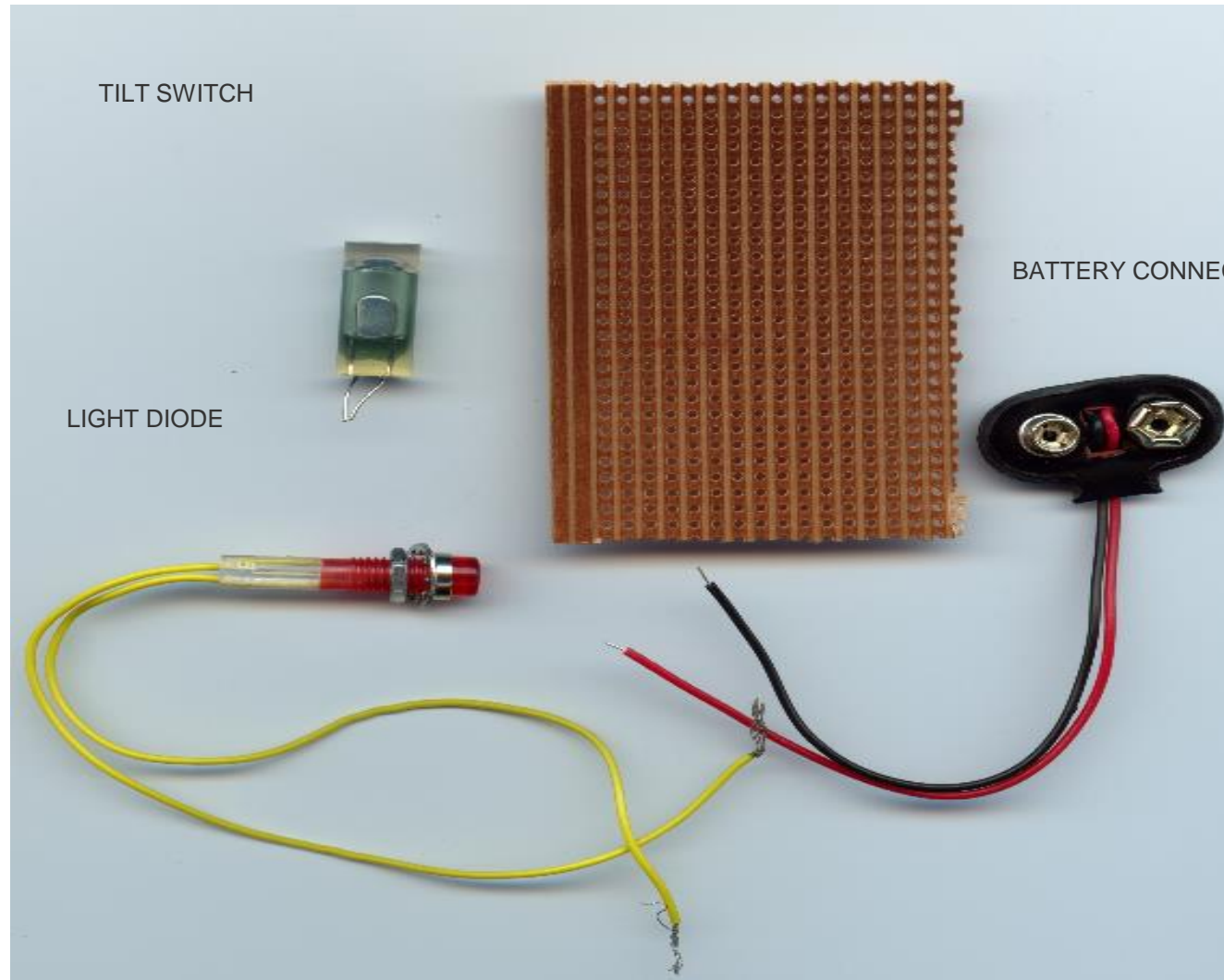

TILT SWITCH

LIGHT DIODE

BATTERY CONNECTION

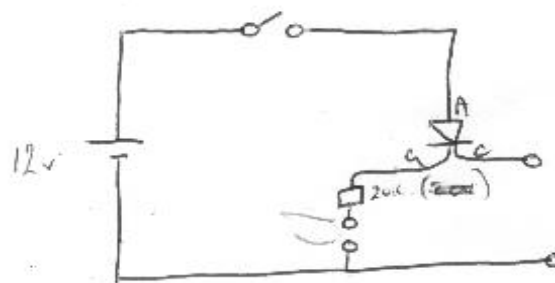
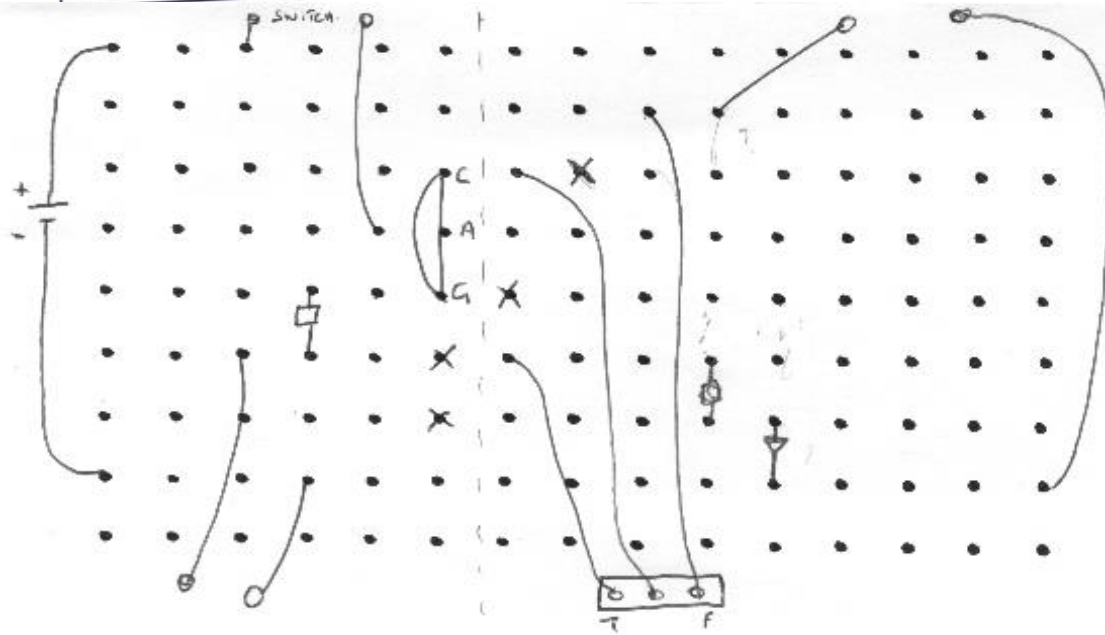

WITH TESTER

CIRCUIT BOARD

Behavioural characteristics

- Individuals:

- Criminal seeking to extort money

- Refugees seeking political asylum

- Mentally disturbed

- Groups

Behavioural characteristics

- What type of people carry out such crimes and what type of character are they? I do not profess to being a trained Trick cyclist, so we will look at specifically the piracy/terrorist hijack scenario.
- Individual pirates/hijackers
 - Criminal seeking to extort money
 - Refugees seeking political asylum
 - Mentally disturbed – the mentally abnormal have a marked inferiority complex, nervousness, hijacking provides an opportunity for the insecure to prove themselves and achieve personal publicity. They could be armed with a hoax weapon or have a bomb in a contained package or wired to devices as suicide bombers, they do not have to be mentally disturbed just a believer in their faith!
- Groups
 - The politically motivated groups of terrorists operate in groups of 2-5, but can be larger dependent on the task in hand, It will possibly be only the leader who will know the overall plan
 - They will possibly know the layout of the vessel, the security and crew procedures and have a fundamental understanding of navigation. They will be well equipped with communications, modern weapons and explosives, which could have been prepositioned on board in advance. They will primarily attempt to access the bridge and using the shock of an armed assault as part of their technique will inevitable gain control of the ship. They will then try to locate the crew/passengers into one part of the ship to ease guarding and control. Initially ruthless, irrational and heavy handed, the elation of their success may ebb away and concern for their own safety and security will be of concern. Unless suicide bombers etc. their aggressive tendencies will reappear as the vessel approaches land or set deadlines.

Behavioural Characteristics

- PERSON(S) SEEN IN AREA FOR NO OBVIOUS REASON
 - PERSON(S) NOT DRESSED FOR THAT PARTICULAR AREA OR FUNCTION
 - PERSON(S) SEEN IN AREA MORE THAN ONCE OR IS NECESSARY
 - PERSON(S) BEING NERVOUS, SWEATY WHEN COMING ABOARD SHIP
 - PERSON(S) HAVING LITRITATURE OR PAPERWORK THAT SEEM TO BE OF A SUSPICIOUS NATURE (INCL. ELECTRONIC ITEMS)
 - PERSON(S) BEING IN POSSESSION OF LARGE SUMS OF MONEY
 - PERSON(S) MEETING OTHER PERSONNEL NOT ASSOCIATED WITH THAT PARTY OR CREW
 - PERSON(S) BEING IN AREAS OF THE SHIP THAT THEY HAVE NO REASON TO BE THERE OR ARE TAKING A PARTICULAR INTEREST IN A PART OF THE SHIP

Recognition and detection of weapons, dangerous substances and devices

- X-Ray screening
- Low powered radar sensors
- Walk through detectors
- Trace detectors
- Screening containers

Search System and Methods

- A search of unlocked spaces
- A search locked spaces
- Personal search locations
- Physical searching
- Metal detection
- Baggage screening
- Heavy baggage
- Vehicles
- Other freight
- Deliveries to ships

Techniques to circumvent security measures

- Surveillance and reconnaissance
- Target reconnaissance
- Rehearsals
- Attack
- Individual
- Information Technology
- Access
- Airborne
- Subsurface

- How can we get around these security measures?
- The criminal or terrorist as an individual or as a group should be treated with the up most respect. The modern terrorist at the height of his profession in some cases is on par with military and civil forces.
- He conducts surveillance and reconnaissance collating timely, accurate and critical information to contribute to the overall political objectives which their group or faith are trying to achieve.
- Target reconnaissance, plans, procedures, patterns, lapses in security, lack of checks etc.
- Rehearsals – support from sympathetic countries and funding
- These are obviously on the large scale, to bring it down to a basic level;
- Information Technology – fraud, hackers, gaining vital info on cargos and shipping movements and security plans etc.
- Access – there are numerous ways to enter the ship whether it is alongside, at anchor or underway
 - Craft marry up together then split, losing radar signature, using local conditions
 - Board a ship midships or stern by the use of poles and ladders and adapted climbing equipment whilst underway
 - Access ladders, gangways, ramps, doors, side scuttles, windows and ports whilst at anchor or alongside.
- And of course stealing a ship by hijacking gaining access by smaller craft or even helicopter and roping down terrorists let alone flying an aircraft into the side of a vessel
- And lets not forget Subsurface attack whilst at anchor or in port, placement of explosives or boarding etc.
- The list is endless and a terrorist or criminal will allow their imagination run wild to achieve their objectives.



Dirty bombs detection or affirmation

